



atech.

GAMME FLEURISSEMENT

SOMMAIRE

CONTENTS

| LA BALCONNIÈRE DESIGN | **03**
DESIGN FLOWERBOX

| LA BALCONNIÈRE CLASSIQUE | **04**
CLASSIC FLOWERBOX

| LA BARRIÈRE FLORALE | **05**
FLORAL BARRIER

| LA SUSPENSION JIFLOR | **06**
JIFLOR SUSPENSION

| LA COLONNE JIFLOR | **07**
JIFLOR COLUMN

| LA SUSPENSION SIFU® | **08**
SIFU® SUSPENSION

| LA POTENCE, LE MÂT, LE BOUQUET ET LA COLONNE | **09**
SUPPORT BRACKET, POLE, BOUQUET AND COLUMN

| L'ENTRÉE DE VILLE | **10**
TOWN ENTRANCE

| LA COLONNE ET LA CASCADE MOBILE | **11**
MOVEABLE COLUMN AND CASCADE

Impression | Print :
L'Écrivain Public www.lecrivainpublic.fr

Octobre 2021 | October 2021

Forts de plus de 30 ans d'expérience dans le monde du fleurissement, nous vous accompagnons vos projets de végétalisation.

Si vous êtes en transition ville verte, afin de répondre à une demande citoyenne, nos produits sont une solution. Balconnière, barrière florale, suspension pour colonne, potence, mât, bouquet ou encore entrée de ville, découvrez au fil des pages les possibilités standards que nous vous proposons.

Pour une gestion de l'eau raisonnée, toutes nos balconnières et suspensions ont une réserve d'eau et une option arrosage automatique ou semi-automatique. N'attendez plus pour fleurir vos villes et y intégrer la nature !

With more than 30 years of experience in the world of flowering, we support you with your greening projects.

If you are in the green city transition, in order to meet a citizen demand, our products are an issue. Flowerbox, floral barrier, suspension for column, bracket, pole, bouquet or even city entrance, discover the standard possibilities that we offer you through the pages.

For a rational water management, all our flowerboxes and suspensions have a water reserve and an automatic or semi-automatic watering option. Do not wait any longer to make your cities flourish and integrate nature into the city!





La balconnière design

Design flowerbox

Balconnière: Polyéthylène recyclable | **Coloris :** 17 coloris au choix
 | **Fixation :** Platine en polyéthylène recyclable (Cloveg'), platine murale en acier galvanisé (Extravase) | **Options :** Platine anti-basculement en acier galvanisé (Rectiligne), bac de culture (Cloveg')

Flowerbox : Recyclable polyethylene | **Colours :** 17 colors at your choice
 | **Fixing :** Wall polyethylene fixing base plate (Cloveg'), wall galvanised steel fixing base plate (Extravase) | **Options :** Galvanised steel fixing base plate (Rectiligne), planting liner (Cloveg')

RECTILIGNE

CLOVEG'

EXTRAVASE

Coloris standards
Standard colours

Coloris texturés
Textured colours

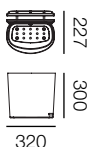
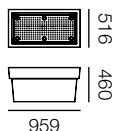

Vol. Substrat - Substrate vol. : 145 l.
 Vol. Eau - Water vol. : 16 l.
 Poids - Weight : 11 kg

Vol. Substrat - Substrate vol. : 9 l.
 Vol. Eau - Water vol. : 1 l.
 Poids - Weight : 2 kg

Vol. Substrat - Substrate vol. : 11 l.
 Poids - Weight : 2,30 kg

Vol. Substrat - Substrate vol. : 37 l.
 Vol. Eau - Water vol. : 3 l.
 Poids - Weight : 4 kg



La balconnière classique

Classic flowerbox

Balconnière: Polyéthylène recyclable (PR800) ou polypropylène recyclable (Série A) avec traitement anti-UV, réserve d'eau avec trop-plein et bouchon de vidange, grille de drainage amovible | **Options:** Bac de culture (sauf A1200 et B950RG), support de fixation en acier galvanisé, système pour arrosage automatique (débit lent) ou semi-automatique (débit rapide) | **Coloris:** Vert ou gris anthracite

Balcony planter: HD Polyethylene (PR800) polypropylene (Série A) with anti-UV treatment, water reserve with overflow and drain plug, drainage grid removable | **Options:** Planting liner (except for A1200 and B950RG), fixing support in galvanized steel, automatic (low-flow) or semi-automatic (high-flow) watering system | **Colours:** Green or anthracite grey



SÉRIE A A SERIE

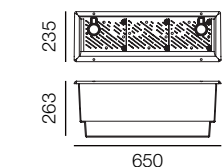

Vol. Substrat - Substrate vol. : 20 l.
Vol. Eau - Water vol. : 5,50 l.
Poids - Weight : 2,600 kg

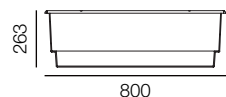

Vol. Substrat - Substrate vol. : 25 l.
Vol. Eau - Water vol. : 7 l.
Poids - Weight : 3 kg

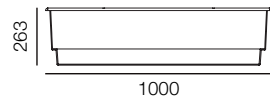

Vol. Substrat - Substrate vol. : 30 l.
Vol. Eau - Water vol. : 9 l.
Poids - Weight : 3,6 kg

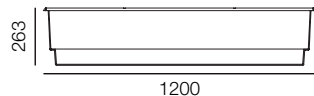

Vol. Substrat - Substrate vol. : 35 l.
Vol. Eau - Water vol. : 11 l.
Poids - Weight : 4,6 kg

B950RG B950RG

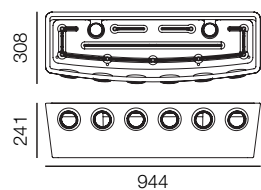

Vol. Substrat - Substrate vol. : 30 l.
Vol. Eau - Water vol. : 6 l.
Poids - Weight : 6 kg

PR800 PR800

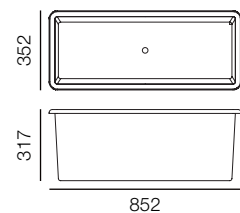

Vol. Substrat - Substrate vol. : 50 l.
Vol. Eau - Water vol. : 9 l.
Poids - Weight : 6 kg



OPTIONS OPTIONS

Bac de culture
Planting liner



Système d'arrosage
Watering system

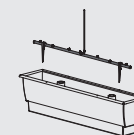

Support muret
Low wall support

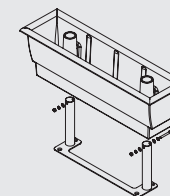

Support mural
Wall support

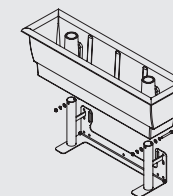

Support sur rambarde
Support on handrail

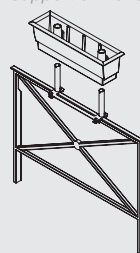

Support sur rambarde | Support on handrail

Support contre rambarde
Support against handrail

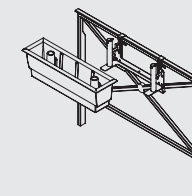

Support contre rambarde | Support against handrail

Balconnière Balcony planter	Rambarde (l x H) Handrail (w x H)	Support Support
Série A / B950RG	40 max x 25 max	45 x 20
Série A / B950RG	60 max x 30 max	63 x 25

Balconnière Balcony planter	Rambarde (l x H) Handrail (w x H)	Support Support
Série A / B950RG	25-40 x 25-83	A1
Série A / B950RG	41-55 x 30-95	A2
Série A / B950RG	56-70 x 30-103	B1
Série A / B950RG	71-90 x 30-123	B2
Série A / B950RG	91-110 x 30-123	B3
Série A / B950RG	111-130 x 30-123	C1
Série A / B950RG	131-150 x 30-123	C2



La barrière florale

Floral barrier

Structure : Acier peint | **Balconnière :** Balconnière Série A (ci-contre)
| Fixation : À sceller, sur platine ou sur fourreau | **Coloris :** RAL ou AkzoNobel au choix

Structure : Hot lacquered steel | **Flowerbox :** Série A (opposite page) | **Fixing :**
 To be embedded, on base plate or by sleeve | **Colours :** RAL or AkzoNobel of your choice

BARRIÈRES DESIGN

DESIGN BARRIERS

PASTEL

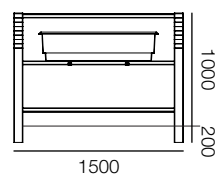

SQUARE

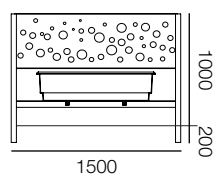

BARRIÈRES AVEC TREILLAGE

BARRIERS WITH TRELLIS

A-LINÉA

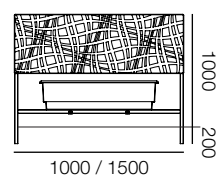

DUALIS

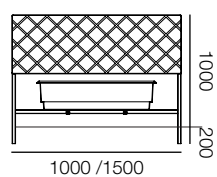

C-NATURA

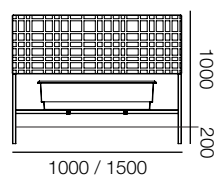

HEDERA

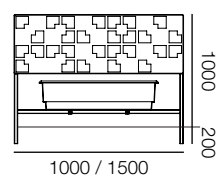

ORIGAMI

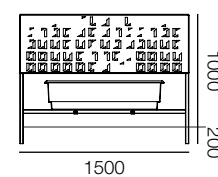

BARRIÈRES CLASSIQUES

CLASSIC BARRIERS

St-André

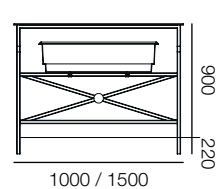

Ste-Anne-d'Auray

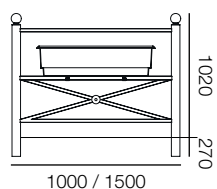

Calypso A

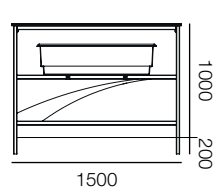

Calypso B

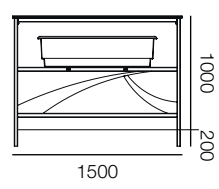

Littoral

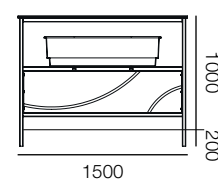

Cordouan

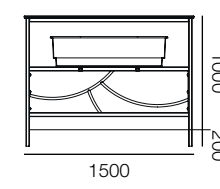

Trinité

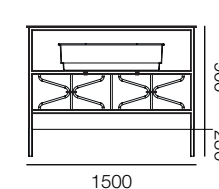

La suspension Jiflor

Jiflor suspension

Jardinière: Polypropylène recyclable avec traitement anti-UV, réserve d'eau avec trop-plein et bouchon de vidange, grille de drainage amovible | **Options:** Bac de culture amovible, support de fixation en polyamide renforcé ou en acier galvanisé, système pour arrosage automatique (débit lent) ou semi-automatique (débit rapide) | **Coloris:** Vert ou gris anthracite

Flowerbox: Polypropylene with anti-UV treatment, water reserve with overflow and drain plug, drainage grid removable | **Options:** Planting liner removable, fixing support in reinforced polyamide or in galvanized steel, automatic (low-flow) or semi-automatic (high-flow) watering system | **Colours:** Green or anthracite grey



OPTIONS Option bac de culture
OPTIONS Culture tub in option



Support mural
Wall support

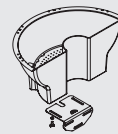

Mâts ronds / Mâts octogonaux
Round poles / Octagonal poles



Système d'arrosage
Watering system

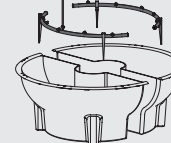

Mâts carrés / Poteaux béton
Square poles / Concrete post

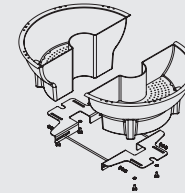

Version double
Double version

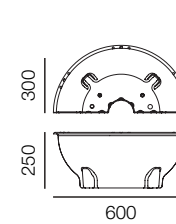
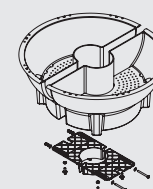

Vol. Substrat - Substrate vol. : 16 l.
Vol. Eau - Water vol. : 5 l.
Poids - Weight : 2 kg

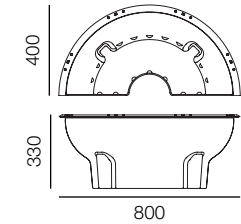

Vol. Substrat - Substrate vol. : 32 l.
Vol. Eau - Water vol. : 10 l.
Poids - Weight : 4 kg



Ø mâts Ø of the pole	Ø 44 - 66	Ø 67 - 89	Ø 90 - 115	Ø 116 - 135	Ø 136 - 158	Ø 159 - 181	Ø 182 - 205	Ø 206 - 228
Jiflor 600	0	A	B	/	/	/	/	/
Jiflor 800	/	A	B	C	D	E	F	G



La colonne Jiflor Jiflor column

Structure : Acier peint | **Suspension :** Jiflor (ci-contre) | **Fixation :** Sur platine | **Coloris :** RAL ou AkzoNobel au choix | **Option :** Rampe d'arrosage automatique ou semi-automatique

Structure : Hot lacquered steel | **Suspension :** Jiflor (opposite page) | **Fixing :** On base plate | **Colours :** RAL or AkzoNobel of your choice | **Option :** Automatic or semi-automatic watering system

6 Jiflor simples
6 single Jiflor

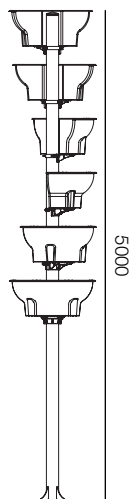

2 Jiflor doubles
2 double Jiflor

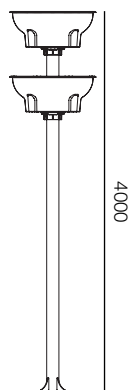

1 Jiflor double
1 double Jiflor

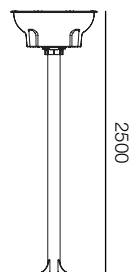

OPTION OPTION

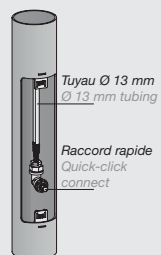

Rampe d'arrosage semi-automatique

Alimentation via une citerne avec connexion sur le raccord rapide - Rampe avec tuyau Ø 13 mm - Connexion sur les couronnes d'arrosage équipées de micro-asperseurs réglables de 0 à 70 litres / h

Rampe intermédiaire pour connexion sur citerne non fournie.

Semi-automatic watering system

Water supply via a water tank with a quick-click connector

- Inside tubing Ø13mm - Connection to irrigation rings -

Watering rings equipped with micro-sprinklers adjustable from 0 to 70 litres / h

Prerequisites : Connection tubing to the water tank.

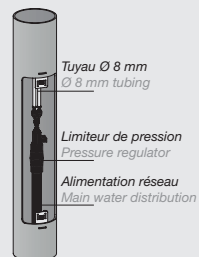

Rampe d'arrosage automatique

Alimentation via le réseau - Rampe avec tuyau Ø 8 mm

- Limiteur de pression avec vannette - Connexion sur les couronnes d'arrosage équipées de goutteurs auto-régulants de 4 litres / h

Alimentation par kit de programmation non fourni.

Automatic watering system

Water supply via the main water distribution - Inside tubing Ø 8 mm - Pressure regulator with low flow valve

- Connection to the irrigation rings - Watering rings

equipped with auto-regulating low-volume irrigation drips

4 litres / h

Prerequisites : Water source by controllers



La suspension Sifu®

Sifu® suspension

Jardinière : Polypropylène recyclable avec traitement anti-UV, réserve d'eau avec trop-plein et bouchon de vidange, grille de drainage amovible | **Options :** Bac de culture amovible, système pour arrosage automatique (débit lent) ou semi-automatique (débit rapide) | **Coloris :** Vert ou gris anthracite

Flowerbox : Polypropylène with anti-UV treatment, water reserve with overflow and drain plug, drainage grid removable | **Options :** Planting liner removable, automatic (low-flow) or semi-automatic (high-flow) watering system | **Colours :** Green or anthracite grey



VASQUE BOWL

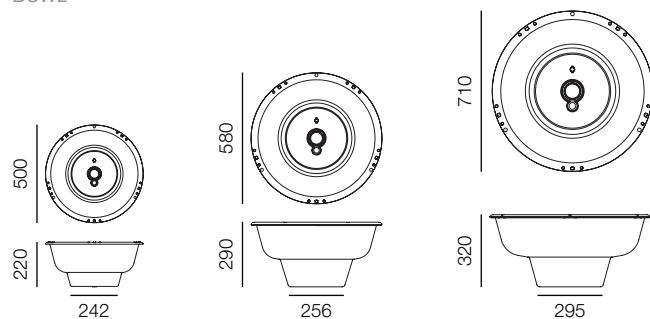

SUSPENSION SIMPLE SINGLE SUSPENSION

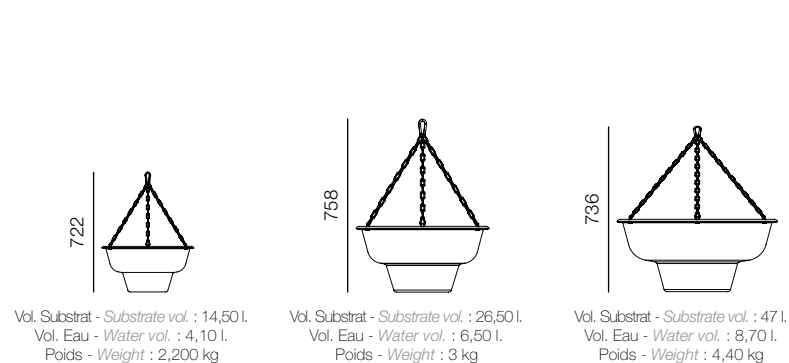

SUSPENSION DOUBLE DOUBLE SUSPENSION

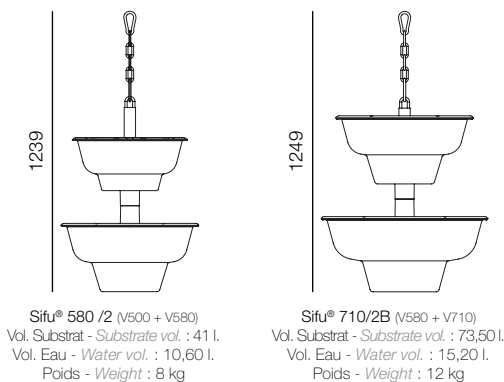

OPTIONS OPTIONS



La potence, le mât, le bouquet et la colonne

Support bracket, pole, bouquet and column



Structure : Acier peint | **Suspension**: Sifu® (ci-contre) | **Fixation** : Murale (potence), sur platine (mât, bouquet, colonne) | **Coloris** : RAL ou AkzoNobel au choix | **Option** : Rampe d'arrosage automatique ou semi-automatique (mât, bouquet, colonne), cf p. 7

Structure : Hot lacquered steel | **Suspension** : Sifu® (opposite page) | **Fixing** : Wall (bracket), on base plate (pole, bouquet, column) | **Colours** : RAL or AkzoNobel of your choice | **Option** : Automatic or semi-automatic watering system (pole, bouquet, column), cf p. 7

POTENCE SUPPORT BRACKET

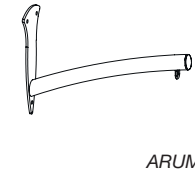
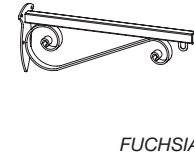
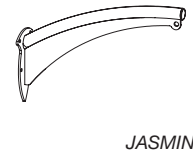
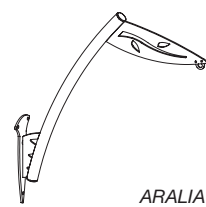
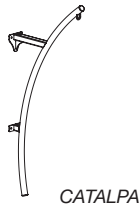
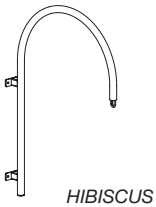

MÂT (hauteur souhaitée à notifier lors de la commande) POLE (height to be notified at the order)

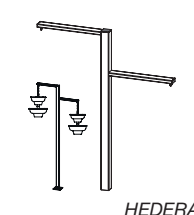
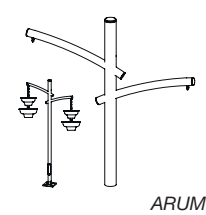
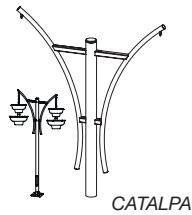

BOUQUET (hauteur souhaitée à notifier lors de la commande) BOUQUET (height to be notified at the order)

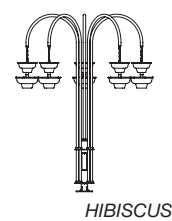
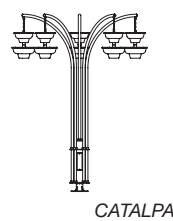
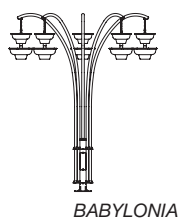

COLONNE (hauteur souhaitée à notifier lors de la commande) COLUMN (height to be notified at the order)

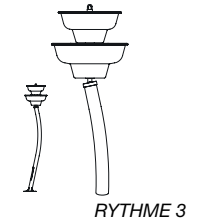
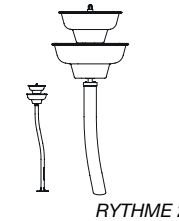
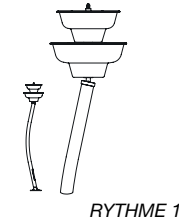
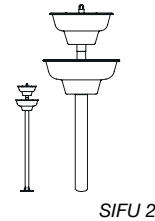
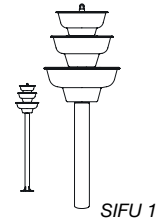

L'entrée de ville

Town entrance

Structure : Acier peint | **Jardinières :** Sifu® (cf p. 8), Série A (cf p. 4), Jiflor (cf p. 6) | **Fixation :** Sur platine ou sabots glissants | **Options :** Système pour arrosage automatique ou semi-automatique, panneau type EB

Structure : Hot lacquered steel | **Planters :** Sifu® (cf p. 8), flowerbox Serie A (cf p. 4), Jiflor (cf p. 6) | **Embedding :** On base plate or slip shoe | **Options :** Automatic or semi-automatic watering system, sign type EB



ARCHE

CATALPA

1/2 CAMÉLIA

ARCEAU CAMÉLIA
CAMELIA ARCH

ARCEAU CLÉMATITE
CLÉMATITE ARCH

ARCEAU BÉGONIA
BÉGONIA ARCH

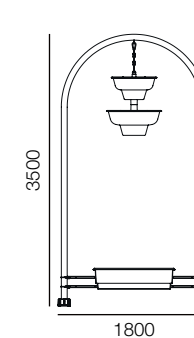
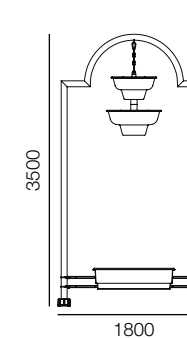
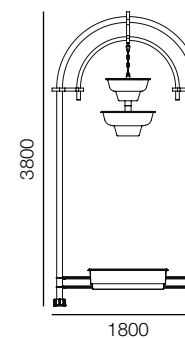
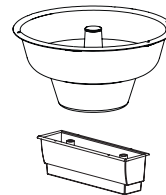
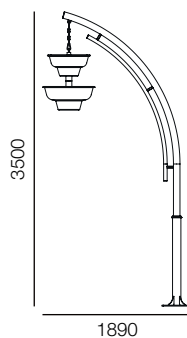
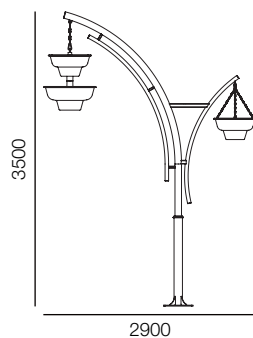
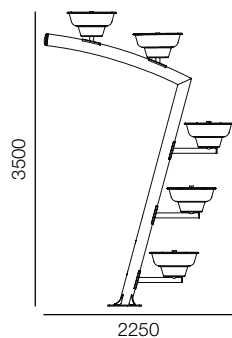
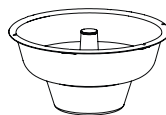

ÉLÉGANCE

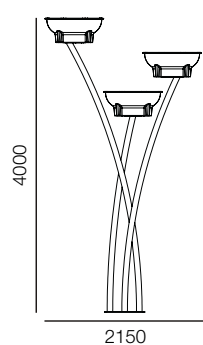
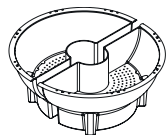



La colonne et la cascade mobile

Moveable column and cascade

Structure : Acier galvanisé et peint RAL 9005 | **Anneaux :** Acier galvanisé
| Manutention : Par transpalette ou levage

Structure : Galvanized and lacquered steel RAL 9005 | **Rings :** Galvanized steel
| Moveable : with pallet jack or lifting

CASCADE MOBILE
 MOVEABLE CASCADE

COLONNE MOBILE
 MOVEABLE COLUMN

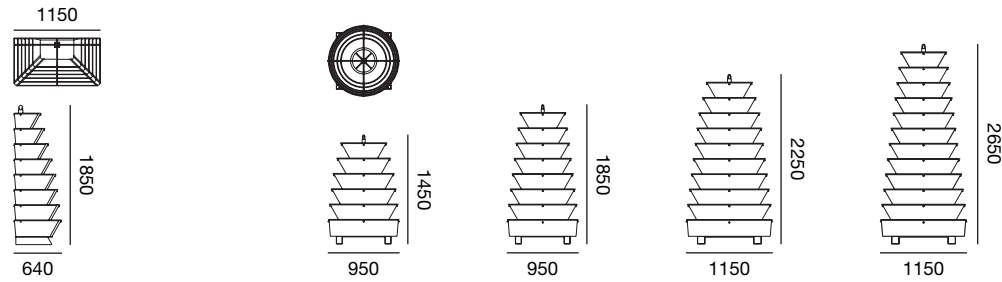



ATECH SAS

ZI de l'Appentière • Mazières-en-Mauges • 49280 Cholet • FRANCE

Tél. : +33 (0)2 41 58 57 13

Mail : contact@atech-sas.com

www.atech-sas.com



8